



Series CN7200, CN7600, CN7800, CN7500  
Microprocessor Based Temperature Process Control

Specifications - Installation and Operating Instructions



**TABLE OF CONTENTS**

Model Number Identification . . . . . 3

Getting Started . . . . . 3

Installation. . . . . 4

Panel Cutout Dimensions . . . . . 4

    Mounting . . . . . 5

Wiring Diagrams . . . . . 6-7

    Front Panel Key Functions . . . . . 8

    Security Features . . . . . 8

    Control Operation Description . . . . . 9-10

    Programming and Operation for Ramp and Soak Feature . . . . . 11-13

    Programming and Operation for PID Function. . . . . 14

    Description of Menu Structure . . . . . 15

    Operation Menu. . . . . 15-16

    Regulation Menu . . . . . 17-19

    Initial Setting Menu . . . . . 20-22

    Alarm Output Description . . . . . 23

    Communication Register List. . . . . 24-25

    Diagnostic Error Messages . . . . . 26

    Specifications . . . . . 29

    Input Sensor Ranges . . . . . 30

    Precautions. . . . . 31

## MODEL NUMBER IDENTIFICATION

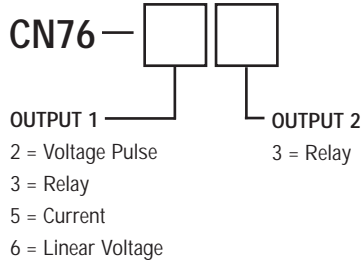
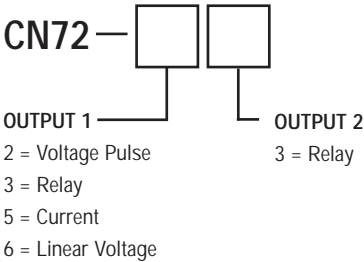
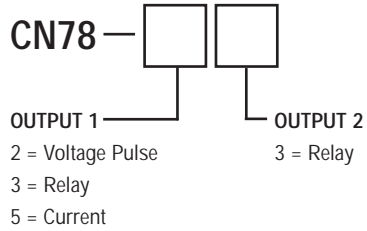
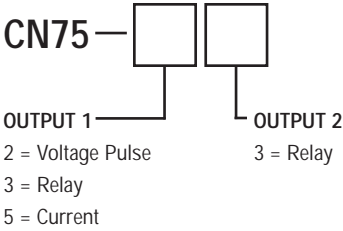

## GETTING STARTED

1. Install the control as described on page 4.
2. Wire your control following the instructions on pages 6-7. Please read the Precautions section located at the end of this manual before wiring the control.
3. For best results when programming changes are necessary, make all changes to the Initial Setting mode (Pages 20-22) before making changes to the Regulation Mode (Pages 17-19) or Operation Mode (Pages 15-16). If any error messages occur, check the Diagnostic Error Message Section (Page 26) for assistance.

## INSTALLATION

Mount the instrument in a location that will not be subject to excessive temperature, shock, or vibration. All models are designed for mounting in an enclosed panel.

Select the position desired for the instrument on the panel. Prepare the panel by cutting and deburring the required opening per the panel cut out dimensions listed below. Follow the mounting instructions listed on page 5. Lastly, wire the controller per the appropriate wiring diagram listed on page 6.

## PANEL CUTOUT DIMENSIONS

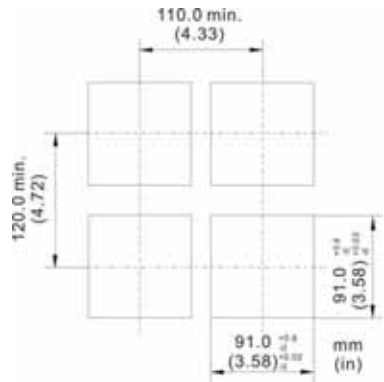
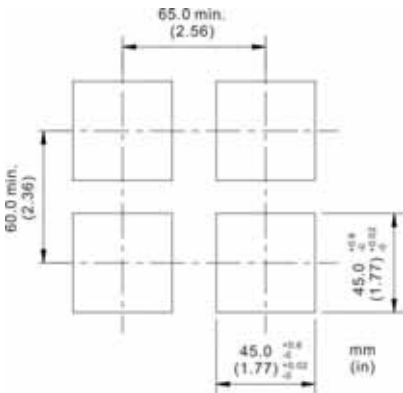
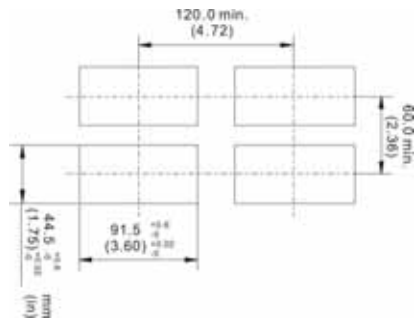
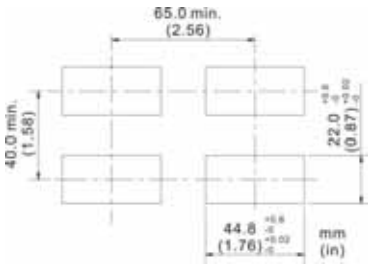

## MOUNTING METHOD

- Step 1: From the front of the panel, slide the controller housing through the cut out. The housing gasket should be against the housing flange before installing.
- Step 2: Insert the mounting brackets into the mounting grooves on the top and bottom of the controller (CN78, CN76, and CN72). For the CN75, slide the mounting collar over the housing from the rear of the panel.
- Step 3: Push the mounting brackets forward until the bracket stops at the panel wall.
- Step 4: Insert and tighten the screws on the bracket to secure the controller in place. (The screw torque should be 0.8 kgf-cm).

### Mounting Bracket Installation

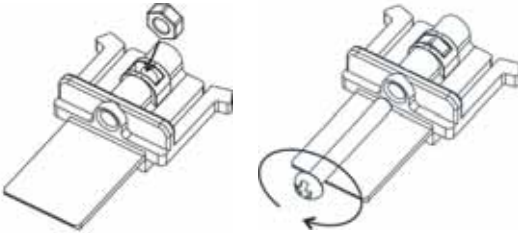

### CN78/CN72/CN76 Mounting Method

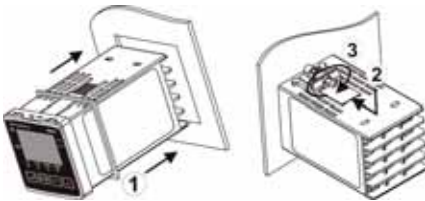

### CN75 Mounting Method

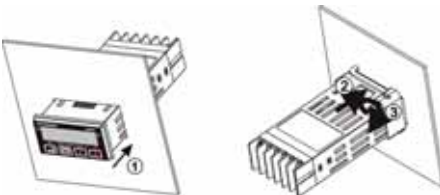

## WIRING

Do not run thermocouple or other class 2 wiring in the same conduit as power leads. Use only the type of thermocouple or RTD probe for which the control has been programmed. Maintain separation between wiring of sensor, auxiliary in or out, and other wiring. See the Initial Setting Menu for input selection.

For thermocouple input always use extension leads of the same type designated for your thermocouple.

For supply connections use No. 16 AWG or larger wires rated for at least 75° C. Use conductors only. All line voltage output circuits must have a common disconnect and be connected to the same pole of the disconnect.

Input wiring for thermocouple, current, and RTD; and output wiring for current 14 VDC is rated CLASS 2.

Control wiring as show below:

## Terminal Identification

### CN75

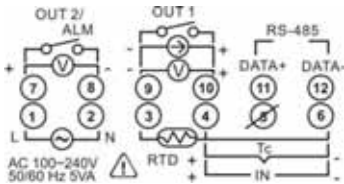

### CN78

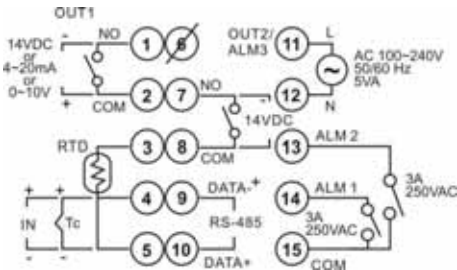

## Terminal Identification (Continued)

### CN72

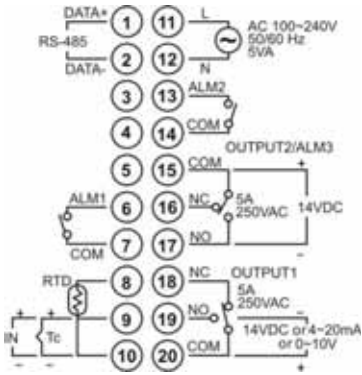

### CN76

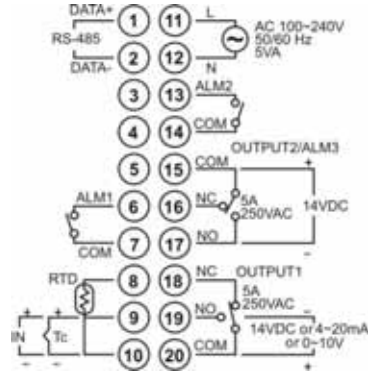

## Wiring for 4 to 20 mA Transmitter Inputs

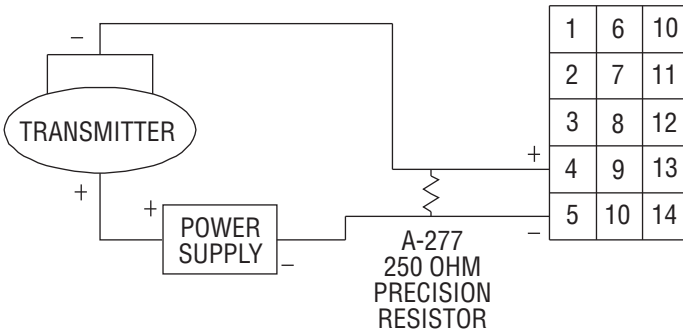

Note: CN78 terminal layout used in above example. Use appropriate terminal layout for selected controller.



## FRONT KEY FUNCTIONS

Key functions are as follows:



**INDEX:** Pressing the INDEX key advances the display to the next menu item.



**UP ARROW:** Increments a value or changes a menu item. If pressed during the Operation Mode, the set point value will be increased.



**DOWN ARROW:** Decrements a value or changes a menu item. If pressed during the **Operation Mode**, the set point value will be decreased.



**ENTER:** Stores the value or item change. If not pressed, the previously stored value or item will be retained. When pressed during the **Operation Mode**, the controller switches to the **Regulation Mode**. If held for more than 3 seconds during the **Operation Mode**, the controller switches to the **Initial Setting Mode**. If pressed during the **Regulation Mode** or **Initial Setting Mode**, the controller will return to the **Operation Mode**.

## SECURITY FEATURES

This series of controllers have two built in security lock settings to prevent unauthorized personnel from changing parameter settings. These parameters are set in the **Operation Mode**.

The LoC1 setting affects all parameters in the controller. If LoC1 setting is enabled, the operator will have to unlock the controller to make any changes to the controller's parameters.

The LoC2 setting affects all parameters except the set point. If LoC2 setting is enabled, the only parameter that the operator will be able to change is the set point. In order to change any other parameters, the operator will have to unlock the control before making a change.

In order to unlock the control, the operator must depress the ENTER and INDEX key simultaneously.



## **CONTROL OPERATION DESCRIPTION**

The HOME display is the normal display while the control is operating. If no errors or functions are active, the HOME display will indicate the Process Variable (the temperature, pressure, flow, %RH, etc.) that is being measured on the top display and the Set Variable on the bottom display.

Items that can change the HOME display are the Ramp and Soak function and any error messages. Descriptions of these special displays follow.

If the Ramp and Soak feature is active, then bottom display will show the current execution pattern and current execution step. The UP and DOWN arrows can be pressed to change the bottom display to show the Set Point (SP) of the current execution step or the Time Remaining (r-ti) of the current execution step. After changing the bottom display to either the Time Remaining or the Set Point, the ENTER key must be pressed to display the values.

Error Messages are shown on page 26.

## Heating, Cooling or Dual Loop Control

Temperature Control can be achieved by either heating or cooling. In the B series controllers, heating and cooling can be operated simultaneously using Dual Loop Output Control to maintain a temperature set point. When Dual Loop Output Control is used, control outputs must be connecting to the heating and cooling devices. Please refer to the following for the operation of each setting.

Control Modes are selected by changing the S-HC parameter in the Initial Setting Mode.

Select HEAT, for heating or reverse acting control for output 1. If selected, output 2 will become alarm 3.

Select Cool, for cooling or direct acting control for output 1. If selected, output 2 will become alarm 3.

Select H1C2 or C1H2 for Dual Loop Output Control for output 1 and 2. If H1C2 is selected, output 1 would be for heating or reverse acting control and output 2 would be for cooling or direct acting control. If C1H2 is selected, output 1 would be for cooling or direct acting control and output 2 would be for heating or reverse acting control.

Setting the control mode to PID when the controller is set for Dual Loop Output Control Activates the Proportional Band Coefficient (CoEF) parameter and the Dead Band (dead) parameter.

The Proportional Band Coefficient (CoEF) sets the Proportional band value for Output 2 based on the Proportional band of output 1. The Proportional Band of Output 2 would be equal to the Proportional Band (Pn) of Output 1 multiplied by the Proportional Band Coefficient (CoEF). The Integral Time (in) and the Derivative Time (dn) will be the same for both Outputs.

The Dead Band (dEAd) parameter sets an area in which the heating and cooling outputs are operating at 0% on. The Dead Band is centered on the Set Point in Dual Loop Output Control mode. Please see the Dead Band illustrated on page 19.

## **RAMP/SOAK PROGRAMMING AND OPERATION**

The ramp/soak feature offers a great deal of flexibility by allowing changes in the set point to be made over a predetermined period of time.

### **Theory of Operation**

This series of controls offer a very simple approach to programming a ramp function. Rather than requiring the operation to calculate an approach rate (usually in degrees per minutes), the series does the calculation internally. Thus, the operator only needs to program the target set point and the time desired to reach that point. When the ramp segment is executed by the control, it calculates the ramp required to move the process from the starting value (current PV) to the desired value (programmed SP) in the time allowed.

Soaks (or dwells) are ramp segments where the target set point is the same as the beginning process value. This allows for multistage ramps without wasting intermediate soak steps. Care must be taken, however, that the process does actually reach the soak value before the soak time starts. If not, the next segment will calculate a slope from the starting PV to the target SP. Depending on your process requirements, this difference may be important. Make sure to test any program for desired results before running production material.

**Do not operate auto-tuning while a ramp function is operating. The ramp function will prevent self tune from operating properly. Make sure that all tuning is set up before operating ramp/soak.**

## Program Setup

All of the programming for the Ramp/Soak function is done in the Initial Setting Mode. You may wish to work out your program on paper before going into the programmer menu sequence.

In the Initial Setting Mode, go to the Control Mode (Ctrl) parameter. Set the parameter to ProG. Press INDEX to the Pattern Editing parameter (PAtn). Use the arrows to select the desired pattern to edit. By setting the Pattern Editing parameter to off, pressing the INDEX key brings up the next parameter in the Initial Setting mode. The Ramp and Soak function is supported by 8 different patterns (pattern numbers 0 to 7). Each pattern contains 8 steps (step numbers 0 to 7) for set point and execution times, one link pattern (Linn) parameter, one cycle parameter (CyCn), and one actual step parameter (PSYn).

The default of step 0 in pattern 0 is a soak function. The control should be programmed to reach the Set Point (SV) temperature, X, after the execution time, T. The unit will control the process temperature (PV) to reach temperature X and keep the temperature at temperature X. The execution time T is determined by the execution time (ti00) for step number 0. The target set point (SP00) for step number 0 should equal the Set Point (SV) temperature.

After the first step, program SP01 and ti01 through SP07 and ti07 for the first pattern. The target set point value (SP0n) is in actual units just like your Set Point (SV). If the control is set for temperature, then the target set point displays are in temperature. If the control is programmed for some other engineering unit, the target set point displays will be set in that unit. The target execution time (ti0n) is in units of time, (hh.mm). The step parameters will be followed by the Actual Step parameter, Cycle parameter, and the Link parameter for each pattern.

The Actual Step parameter (PSYn) sets the last executable step for the current pattern. For example, if the Actual Step parameter is set to 2 for pattern 0, then the program will only run steps 0, 1, and 2 for pattern 0.

The Cycle parameter (CyCn) determines how many times the current pattern is repeated. For example, if the Cycle parameter for pattern 0 is set to 2, the steps in pattern 0 will be repeated twice before moving on to the next pattern.

The Link parameter (Linn) assigns the next pattern for the program to execute. For example, if the Link parameter is set to 3 for pattern 0, the program will skip patterns 1 and 2 and start executing pattern 3 after pattern 0 is complete. If the Link parameter is set to off, the program will stop after executing the current pattern and the temperature will be maintained at the set point of the last step executed.

## **Execution**

The execution of the ramp and soak feature is initiated through the Run/Stop parameter, (r-S) in the Operation Mode. The Run/Stop parameter has four possible values.

If the Run/Stop parameter is set to rUn, the program will start to execute in order from step 0 of the start pattern.

If the Run/Stop parameter is set to Program Stop (PStP), the program will stop and maintain the temperature of the last set point before the program was halted. When the Run/Stop parameter is restarted, the program will restart and execute from step 0 of the start pattern. The start pattern selection (Ptrn) is only available when the Run/Stop parameter is set to Program Stop.

If the Run/Stop parameter is set to Program Hold (PHod), the program will be paused and the temperature will be maintained at the set point temperature that was active prior to the program hold. Once the Run/Stop parameter is set back to run, the program will follow the step before the hold and start to execute through the rest of the program.

## **Display**

During ramp and soak program control, the SV default display is P-XX, where P indicates the current execution pattern and XX indicates the display item to Set Point Value (SP) or Residual Time (r-ti). The Set Point Value will display the temperature set point of the current execution step in the SV display. The Residual Time will display the remaining time of the current execution step in the SV display. After selecting the Set Point Value or Residual Time, the ENTER key must be pressed to accept the display change.

## **PROGRAMMING AND OPERATION FOR PID**

### **Theory of Operation**

The PID method of control is based on the individual tuning of proportional band values, integral time values, and derivative time values to help a unit automatically compensate for changes in a control system. The proportional band is the range around the set point in which the control's proportioning takes place. The control increases or decreases the output proportionately to the process temperature's deviation from the set point. The integral time eliminates undershoot and overshoot of the set point by adjusting the proportioning control based on the amount of deviation from the set point during steady state operation. The derivative time eliminates undershoot and overshoot by adjusting the proportioning control based on the rate of rise or fall of the process temperature. The integral deviation offset correction (ioFn) improves the speed in which the process value reaches the set point value. If this parameter is set to zero, the output will be zero when the process value is equal to the set point value. If the integral time parameter is used only to eliminate steady state error, it may take a long time to reach the set point because it needs time to accumulate the error. This parameter defines the default output level on start up. When the integral time is set at 0, then the proportional derivative offset correction (PdoF) would replace the integral deviation offset correction, but serves the same function.

### **Program Set Up**

In order to use the PID function in the B series controllers, the Control Mode will have to be set to PID in the Initial Setting Menu. After changing the Control Mode, the PID parameters can be accessed in the Regulation Menu. The PID parameters can either be programmed manually or they can be set by the controller using the auto tune function. The auto tune will use trial and error to tune the PID parameters to give the control the most precise control. Since the time to accurately tune the control may differ depending on the process, the controller can also be manually tuned to known PID values prior to running auto tune. The Run/Stop parameter must be set to run in order to start auto tuning.

The controller has four user-defined profiles (PID0 to PID3) of PID values along with an auto selection function (PID4). Each set of PID values includes a set point value (Svn), proportional band (Pn), integral time (in), derivative time (dn), and integral deviation setting (iofn). If PID4 is selected, the controller will pick which set of user defined parameters to use based on how close the set point value of the profile is to the current process value.

## DESCRIPTION OF MENU STRUCTURE

The programming for the controller is broken down into three menus (Operation, Regulation, and Initial Setting). Upon normal operation, control will be in the Operation Menu.

### OPERATION MENU

Pressing the INDEX key will cycle through the below menu items. The parameter will be displayed in the top display, while its value will be displayed in the bottom display, except for the set point which is displayed in the bottom display on the Home Display. The UP and DOWN arrows change the values of the parameters. The ENTER key must be pressed after any changes.

<i>1234</i>	Adjust the set point value - Can be any numerical value between the upper and lower limit of the temperature range.
<i>r-S</i>	Select Run - Stop Output Control.
<i>rUn</i>	Activates outputs and Starts Ramp/Soak.
<i>StoP</i>	De-activates outputs and Stops Ramp/Soak.
<i>PStP</i>	Halts Ramp/Soak program, outputs remain active. Only available during ramp/soak operation. Program restarts at Step 0 of Start Pattern.
<i>PHod</i>	Pauses Ramp/Soak program, outputs remain active. Only available during ramp/soak operation. Program restarts at step prior to program being held.
<i>Pttrn</i>	Set Start pattern for Ramp/Soak. Only available when r - S set to PStP.
<i>SP</i>	Number of digits to the right of the decimal. Decimal Point Position can be set for all Inputs except for B, S, and R type thermocouples.
<i>AL 1H</i>	Alarm 1 High Set Point. May not appear depending on ALA1 setting in Initial Setting Menu.

<i>AL 1L</i>		Alarm 1 Low Set Point. May not appear depending on ALA1 setting in Initial Setting Menu.
<i>AL2H</i>		Alarm 2 High Set Point. May not appear depending on ALA2 setting in Initial Setting Menu.
<i>AL2L</i>		Alarm 2 Low Set Point. May not appear depending on ALA2 setting in Initial Setting Menu.
<i>AL3H</i>		Alarm 3 High Set Point. May not appear depending on ALA3 setting in Initial Setting Menu.
<i>AL3L</i>		Alarm 3 Low Set Point. May not appear depending on ALA3 setting in Initial Setting Menu.
<i>LoC</i>		Set front panel security lock.
	<i>LOC 1</i>	Lock all settings.
	<i>LOC 2</i>	Lock all settings except the set point.
<i>out 1</i>		Display the % output value for output 1. In manual mode, this value can be changed using the up and down arrows.
<i>out 2</i>		Display the % output value for output 2. In manual mode, this value can be changed using the up and down arrows.



## REGULATION MENU

Press the ENTER key while at the Home Display in order to access the Regulation Menu. Pressing the INDEX key will cycle through the below menu items. The parameter will be displayed in the top display, while its value will be displayed in the bottom display. The UP and DOWN arrows change the values of the parameters. The ENTER key must be pressed after any changes.

<i>AT</i>	Auto Tune. The controller will evaluate the process and select the PID values to maintain good control. Only available when the control mode is set to PID.
<i>on</i>	Start learning the process. After the process has been learned the menu will revert to oFF.
<i>oFF</i>	Disables Auto Tune.
<i>Pidn</i>	Selection of PID profile. The controller can store up to 4 PID profiles. The top display will show the PID profile and the bottom display will show the target set value for that profile. When Pid4 is selected, the controller will automatically select which PID profile to use based on the target set values. Only available when control mode is set to PID. See Programming and Operation of PID function for more information. (n = 0 to 4)
<i>Svn</i>	Target Set Value associated with each PID Profile. (n = 0 to 3).
<i>Pn</i>	Proportional Band Setting associated with each PID Profile. (n = 0 to 3).
<i>in</i>	Integral time (reset time) associated with each PID Profile. (n = 0 to 3).
<i>dn</i>	Derivative time (rate time) associated with each PID Profile. (n = 0 - 3).
<i>ioFn</i>	Integral Deviation Offset Correction associated with each PID Profile. (n = 0 to 4)

*PdoF*

PD Offset Correction Setting. only available when control mode is set to PID and integral time = 0. See Programming and Operation of PID function for moving information.

*HtS*

Heating Hysteresis (Differential) Setting. Sets the value for the amount of difference between the turn off point (set point) and the turn on point. Figure A shows the output behavior for a heating (reverse acting) application. Only available when control mode set to on/off control.

*CtS*

Cooling Hysteresis (Differential) Setting. Sets the value for the amount of difference between the turn off point (set point) and the turn on point. Figure A shows the output behavior for a cooling (direct acting) application. Only available when control mode set to on/off control.

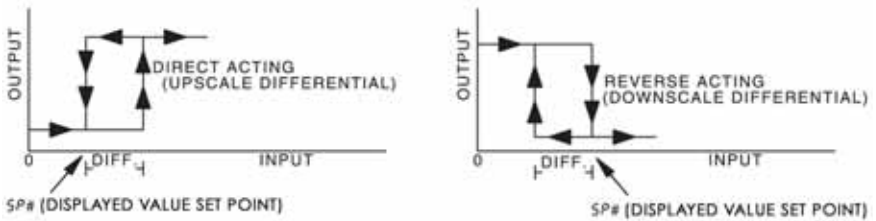

Figure A: Output behavior for Heating/Cooling On/Off Applications

*HtPd*

Heating Control Cycle Setting. Defines the duration for one output period or cycle for output 1. Only available when control mode is set to PID or ProG and Output 1 is set for heating.

*CtPd*

Cooling Control Cycle Setting. Defines the duration for one output period or cycle for output 1. Only available when control mode is set to PID or ProG and Output 1 is set for cooling.

*HCPd*

Control Cycle setting for output 2. Defines the duration for one output period or cycle for output 2. Only available when control mode is set to PID and Dual Loop Output Control.

*CoEF*

Proportional Band Coefficient. Sets the value of the proportional band for output 2. The proportional band of output 2 is equal to the proportional band of output 1 multiplied by the proportional band coefficient. This parameter is only available when the control mode is set to PID and Dual Loop Output Control.

*DEAD*

Dead Band. The zone centered on the set point in which the control is thought to be at the desired set level. The outputs will be turned off at this point unless there is an integral deviation offset or the dead band is negative. This parameter is only shown when the control is set to Dual Loop Output Control.

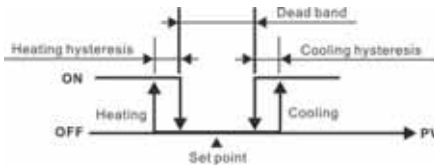

Output operation of ON/OFF control during dual loop output control.

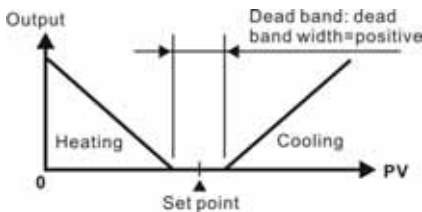

PID control Dead Band is positive.

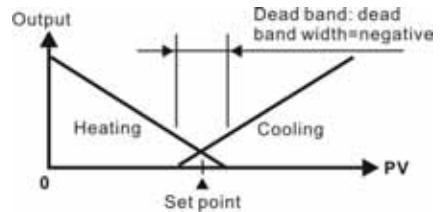

PID control, Dead Band is negative.

Figure B: Output Operation during dual loop control

*tPof*

Process Temperature Offset. This feature allows the input value to be changed to agree with an external reference or to compensate for sensor error.

*Crh*

Analog Output High Limit: Sets the actual upper limit of the analog output when the control's output is operating at 100%. Only available for analog output models.

*CrLo*

Analog Output Low Limit: Sets the actual lower limit of the analog output when the control's output is operating at 0%. Only available for analog output models.

## INITIAL SETTING MENU

Press and hold the ENTER key for at least 3 seconds while at the Home Display in order to access the Initial Setting Menu. Pressing the INDEX key will cycle through the below menu items. The parameter will be displayed in the top display, while its value will be displayed in the bottom display. The UP and DOWN arrows change the values of the parameters. The ENTER key must be pressed after any changes.

**inPt**

Input Selection. Select one of the following input types from the below table. For Current inputs, a 250 Ohm Resistor must be wired across the input terminals.

Input Temperature Sensor Type	LED Display	Temperature Range
Thermocouple TXK type	TXK	-328 ~ 1472°F (-200 ~ 800°C)
Thermocouple U type	U	-328 ~ 932°F (-200 ~ 500°C)
Thermocouple L type	L	-328 ~ 1562°F (-200 ~ 850°C)
Thermocouple B type	b	212 ~ 3272°F (100 ~ 1800°C)
Thermocouple S type	S	32 ~ 3092°F (0 ~ 1700°C)
Thermocouple R type	r	32 ~ 3092°F (0 ~ 1700°C)
Thermocouple N type	n	-328 ~ 2372°F (-200 ~ 1300°C)
Thermocouple E type	E	32 ~ 1112°F (0 ~ 600°C)
Thermocouple T type	t	-328 ~ 752°F (-200 ~ 400°C)
Thermocouple J type	J	-148 ~ 2192°F (-100 ~ 1200°C)
Thermocouple K type	K	-328 ~ 2372°F (-200 ~ 1300°C)
Platinum Resistance (Pt100)	Pt	-328 ~ 1112°F (-200 ~ 600°C)
Platinum Resistance (JPt100)	JPt	-4 ~ 752°F (-20 ~ 400°C)
0~50mV Analog Input	0.5	-999 ~ 9999
0V ~ 10V Analog Input	0.10	-999 ~ 9999
0V ~ 5V Analog Input	0.5	-999 ~ 9999
4 ~ 20mA Analog Input	0.04	-999 ~ 9999
0~20mA Analog Input	0.00	-999 ~ 9999

**TEMP**

Temperature Units. This parameter is only available for thermocouple or RTD inputs.

**TEMP-H**

Scale High Limit. Sets the upper limit of the temperature range. If the process temperature exceeds this setting, the display will flash an error code.

**TEMP-L**

Scale Low Limit. Sets the lower limit of the temperature range. If the process temperature exceeds this setting, the display will flash an error code.

<b>Ctrl</b>	Control Mode. Select method of control operation. Can be set to PID, On-Off, Manual, or Ramp/Soak Programming.
<b>PATn</b>	Ramp/Soak Pattern Selection. Allows user to select which of the 8 ramp/soak patterns to program. Each pattern has 8 steps which gives a total of 64 possible steps in a single program. When finished programming all ramp and soak patterns, the parameter should be set to off. (n = 0 to 7)
<b>SPny</b>	Segment Set Point for pattern n and step y. For example the first step of the first pattern would be SP00. The last step would be SP77. (n = 0 to 7, y = 0 to 7)
<b>ti ny</b>	Segment Time for pattern n and step y. For example the first step of the first pattern would be ti00. The last step would be Ti77. The value of this parameter will be in HH:MM. (n = 0 to 7, y = 0 to 7)
<b>PSyn</b>	Last Step for pattern n. Sets the last step that will be performed in the current pattern. (n = 0 to 7)
<b>CYCn</b>	Pattern Loop Setting for pattern n. Sets the number of times that the current pattern will be repeated. (n = 0 to 7)
<b>Link</b>	Pattern Link for pattern n. Sets the next pattern that will be performed after the current pattern. When set to off, the program will end and maintain last set point. (n = to 7)
<b>S-HC</b>	Heat/Cool Selection. Assigns output 1 and output 2 to be either heat or cool.  HEAt = Output 1 = Heating Cool = Output 1 = Cooling H1C2 = Output 1 = Heating; Output 2 = Cooling H2C1 = Output 1 = Cooling; Output 2 = Heating
<b>ALA 1</b>	Alarm 1 Setting. Sets operation for Alarm 1. Please see selection on Alarm Outputs for description of the outputs.
<b>ALA2</b>	Alarm 2 Setting. Sets operation for Alarm 2. Please see selection on Alarm Outputs for description of the outputs.
<b>ALA3</b>	Alarm 3 Setting. Sets operation for Alarm 3. Please see selection on Alarm Outputs for description of the outputs. (not available for Dual Loop Output Control)

*SALA*

System Alarm Setting. Selects which of the alarm outputs is used if a system alarm occurs. The system alarms would be an input error or a process control failure. This feature can be disabled by turning this parameter to oFF.

*CoSH*

Communications Write Function Feature. Allows parameters to be changed via the RS-485 communications. Setting to oFF prevents any changes from remote users.

*C-SL*

Protocol Selection: Select whether to communicate using ASCII or RTU Protocol. This value must match the protocol used by the host computer.

*C-no*

Controller Address: Set from 1 to 247. This value must match the controller address used by the host computer.

*LEn*

Communication Data Length. Choose either 7 or 8. This value must match the communication data length of the host computer.

*Prty*

Communication Parity Bit. Set this value to even, odd, or none. This value must match the communication parity bit of the host computer.

*Stop*

Communication Stop Bit. Set this value to 1 or 2. This value must match the communication stop bit of the host computer.

## Alarm Output Configuration and Operation Table.

Set Value	Alarm Type	Alarm Output Operation
0	Alarm function disabled	Output is OFF
1	Deviation upper- and lower-limit: This alarm output operates when PV value is higher than the setting value SV+(AL-H) or lower than the setting value SV-(AL-L).	
2	Deviation upper-limit: This alarm output operates when PV value is higher than the setting value SV+(AL-H).	
3	Deviation lower-limit: This alarm output operates when PV value is lower than the setting value SV-(AL-L).	
4	Reverse deviation upper- and lower-limit: This alarm output operates when PV value is in the range of the setting value SV+(AL-H) and the setting value SV-(AL-L).	
5	Absolute value upper- and lower-limit: This alarm output operates when PV value is higher than the setting value AL-H or lower than the setting value AL-L.	
6	Absolute value upper-limit: This alarm output operates when PV value is higher than the setting value AL-H.	
7	Absolute value lower-limit: This alarm output operates when PV value is lower than the setting value AL-L.	
8	Deviation upper- and lower-limit with standby sequence: This alarm output operates when PV value reaches set point (SV value) and the value is higher than the setting value SV+(AL-H) or lower than the setting value SV-(AL-L).	
9	Deviation upper-limit with standby sequence: This alarm output operates when PV value reaches set point (SV value) and the reached value is higher than the setting value SV+(AL-H).	
10	Deviation lower-limit with standby sequence: This alarm output operates when PV value reaches the set point (SV value) and the reached value is lower than the setting value SV-(AL-L).	
11	Hysteresis upper-limit alarm output: This alarm output operates if PV value is higher than the setting value SV+(AL-H). This alarm output is OFF when PV value is lower than the setting value SV+(AL-L).	
12	Hysteresis lower-limit alarm output: This alarm output operates if PV value is lower than the setting value SV-(AL-H). This alarm output is OFF when PV value is higher than the setting value SV-(AL-L).	
13	CT alarm output: This alarm operates when the current measured by transformer (CT) is lower than AL-L or higher than AL-H (This alarm output is available only for the controller with current transformer).	
14	When program control is end status, alarm output is ON.	
15	When RAMP UP status happens to PID program control, alarm output is ON.	
16	When RAMP DOWN status happens to PID program control, alarm output is ON.	
17	When SOAK status happens to PID program control, alarm output is ON.	
18	When RUN status happens to PID program control, alarm output is ON.	

(Note: AL-H and AL-L include AL1H, AL2H, AL3H and AL1L, AL2L, AL3L)

## Communication Register List

- Supporting transmission speed: 2400, 4800, 9600, 19200, 38400 bps.
- Non-supported formats: 7, N, 1 or 8, O, 2 or 8, E, 2.
- Communication protocol: Modbus (ASCII or RTU).
- Function code: 03H to read the contents of register (Max. 8 words). 06H to write 1 (one) word into register. 02H to read the bits data (Max. 16 bits). 05H to write 1 (one) bit into register.
- Address and Content of Data Register:

Address	Content	Explanation
1000H	Process value (PV)	Measuring unit is 0.1, updated one time in 0.4 second. The following reading value display indicates error occurs: 8002H : Initial process (Temperature value is not got yet) 8003H : Temperature sensor is not connected 8004H : Temperature sensor input error 8006H : Cannot get temperature value, ADC input error 8007H : Memory read/write error
1001H	Set point (SV)	Unit is 0.1, oC or oF
1002H	Upper-limit of temperature range	The data content should not be higher than the temperature range
1003H	Lower-limit of temperature range	The data content should not be lower than the temperature range
1004H	Input temperature sensor type	Please refer to the contents of the "Temperature Sensor Type and Temperature Range" for detail
1005H	Control method	0: PID, 1: ON/OFF, 2: manual tuning, 3: PID program control
1006H	Heating/Cooling control selection	0: Heating, 1: Cooling, 2: Heating/Cooling, 3: Cooling/Heating
1007H	1st group of Heating/Cooling control cycle	0-99, 0:0.5 sec
1008H	2nd group of Heating/Cooling control cycle	0-99, 0:0.5 sec
1009H	PB Proportional band	0.1 ~ 999.9
100AH	Ti Integral time	0-9999
100BH	Td Derivative time	0-9999
100CH	Integration default 0-100%, unit is 0.1%	
100DH	Proportional control offset error value, when Ti = 0	0-100%, unit is 0.1%
100EH	The setting of COEF when Dual Loop output control are used	0.01 ~ 99.99
100FH	The setting of Dead band when Dual Loop output control are used	-999 ~ 9999
1010H	Hysteresis setting value of the 1st output group	0 ~ 9999
1011H	Hysteresis setting value of the 2nd output group	0 ~ 9999
1012H	Output value read and write of Output 1	Unit is 0.1%, write operation is valid under manual tuning mode only.
1013H	Output value read and write of Output 2	Unit is 0.1%, write operation is valid under manual tuning mode only.
1014H	Upper-limit regulation of analog linear output	1 Unit = 2.8uA(Current Output) = 1.3mV(Linear Voltage Output)
1015H	Lower-limit regulation of analog linear output	1 Unit = 2.8uA(Current Output) = 1.3mV(Linear Voltage Output)
1016H	Temperature regulation value	-999 ~ +999, unit: 0.1
1017H	Analog decimal setting	0 ~ 3
101CH	PID parameter selection	0-4
101DH	SV value corresponded to PID value	Only valid within available range, unit: 0.1 scale
1020H	Alarm 1 type	Please refer to the contents of the "Alarm Outputs" for detail
1021H	Alarm 2 type	Please refer to the contents of the "Alarm Outputs" for detail
1022H	Alarm 3 type	Please refer to the contents of the "Alarm Outputs" for detail
1023H	System alarm setting	0 : None (default), 1-3 : Set Alarm 1 to Alarm 3
1024H	Upper-limit alarm 1	Please refer to the contents of the "Alarm Outputs" for detail
1025H	Lower-limit alarm 1	Please refer to the contents of the "Alarm Outputs" for detail



Address	Content	Explanation
1026H	Upper-limit alarm 2	Please refer to the contents of the "Alarm Outputs" for detail
1027H	Lower-limit alarm 2	Please refer to the contents of the "Alarm Outputs" for detail
1028H	Upper-limit alarm 3	Please refer to the contents of the "Alarm Outputs" for detail
1029H	Lower-limit alarm 3	Please refer to the contents of the "Alarm Outputs" for detail
102AH	Read LED status	b0 : Alm3, b1: Alm2, b2: F, b3: _, b4: Alm1, b5: OUT2, b6: OUT1, b7: AT
102BH	Read push button status	b0 : Set, b1 : Select, b2 : Up, b3 : Down. 0 is to push
102CH	Setting lock status	0 : Normal, 1 : All setting lock, 11 : Lock others than SV value
102FH	Software version	V1.00 indicates 0x100
1030H	Start pattern number	0 ~ 7
1040H-1047H	Actual step number setting inside the correspond pattern	0 ~ 7 = N, indicate that this pattern is executed from step 0 to step N
1050H-1057H	Cycle number for repeating the execution of the correspond pattern	0 ~ 99 indicate that this pattern has been executed for 1 ~ 100 times
1060H-1067H	Link pattern number setting of the correspond pattern	0 ~ 8, 8 indicates the program end. 0~7 indicates the next execution pattern number after executing the current pattern
2000H-203FH	Pattern 0~7 temperature set point setting Pattern 0 temperature is set to 2000H~2007H	-999 ~ 9999
2080H-20BFH	Pattern 0-7 execution time setting Pattern 0 time is set to 2080H-2087H	Time 0 ~ 900 (1 minute per scale)

6. Address and Content of Bit Register: ( First bit of reading will put into LSB, Write data = FF00H for bit set, 0000H for bit clear)

Address	Content	Explanation
0810H	Communication write-in selection	Communication write in disabled: 0 (default), Communication write in enabled: 1
0811H	Temperature unit display selection	oC / linear input (default) : 1 , oF : 0
0812H	Decimal point position selection	Except for the thermocouple B, S, R type, all the other thermocouple type are valid. (0 or 1)
0813H	AT setting	OFF: 0 (default), ON : 1
0814H	Control RUN/STOP setting	0 : STOP, 1 : RUN (default)
0815H	STOP setting for PID program control	0: RUN (default), 1: STOP
0816H	Temporarily STOP for PID program control	0: RUN (default), 1: Temporarily STOP

## DIAGNOSTIC ERROR MESSAGES

### Display Error Messages

Display		Description	Action Required
PV	b150	Display on Start Up	No Action Required
SV	rr		
PV	No	No Input Probe Connection	Verify that sensor is wired to proper terminals. Next, check that the controller is programmed for the correct input type. Most commonly seen when controller is programmed for a RTD, while a thermocouple is connected.
SV	Cont		
PV	Err	Input Error	Verify that the input is wired to the proper terminals. Next check to see if the input type is set to the proper value. Most commonly seen when controller is programmed for a 4 to 20 mA input and 0 to 20 mA signal is wired to the controller.
SV	inPt		
PV	2001	Process Value Flashes when outside of range	Input signals may normally go above or below range limits. If not check input and correct the process temperature or increase temperature range limits using tP-H and tP-L.
SV	0.0		
PV	Err	Error EEPROM	Attempt to reset the factory default settings using the instructions in the next section. If still has error, call customer service for a return goods authorization number to have the controller evaluated at the factory.
SV	Pron		

### Communication Error Messages

<b>Error Status</b> <b>102EH/4750H</b>	<b>PV read back</b> <b>1000H/4700H</b>	<b>Error Status</b>
0001H	N/A	PV Unstable
0002H	8002H	Re-initialize, no temperature at this time
0003H	8003H	Input sensor did not connect
0004H	8004H	Input Signal Error
0005H	N/A	Over Input Range
0006H	8006H	ADC fail
0007H	N/A	EEPROM read/write error

## Reset Factory Default Settings

Note: Resetting Factory Default Settings erases all of the values entered by the user. Record any necessary settings before proceeding.

Warning: Erasing the user entered values may result in a safety hazard and system malfunction.

The following instructions will reset the controller to the original factory default settings.

- Step 1. Press the INDEX KEY while at the Home Display until the controller reads LoC in the process display. Use the UP arrow to select LoC1. Press the ENTER KEY to save this value.
- Step 2. Press and hold the UP and DOWN arrows simultaneously for one second. Upon releasing the buttons, the display will read SHou in the PV display and OFF in the SV display.
- Step 3. Press the INDEX key once and the controller will read PASS in the PV display and a 4321 in the SV display. Adjust the value in the SV display to 1357 using the UP and DOWN arrows. Press the ENTER KEY to save the value.
- Step 4. Cycle the power on the controller. Upon power up, all of the user set values have been erased.

## SPECIFICATIONS

<b>Input Voltage</b>	100 to 240VAC 50/60Hz.
<b>Operation Voltage Range</b>	85% to 110% of rated voltage.
<b>Power Consumption</b>	5VA max.
<b>Memory Protection</b>	EEPROM 4K bit (non-volatile memory (number of writes: 1000,000)).
<b>Display Method</b>	2 line x 4 character 7-segment LED display Process value (PV): Red color, Set point (SV): Green color.
<b>Sensor Type</b>	Thermocouple: K, J, T, E, N, R, S, B, L, U, TXK. 3-wire platinum RTD: Pt100, JPt100. Analog input 0~5V, 0~10V, 0~20mA, 0~50mV.
<b>Control Mode</b>	PID, ON/OFF, Manual or PID program control (Ramp/Soak control).
<b>Control Output</b>	Relay output: SPDT (SPST: 1/16 DIN and 1/32 DIN size), Max. load 250VAC, 5A resistive load. Voltage pulse output: DC 14V, Max. output current 40mA. Current output: DC 4~20mA output (Load resistance: Max. 600Ω). Linear voltage output: 0~5V, 0~10V *(B Series only).
<b>Display Accuracy</b>	0 or 1 digit to the right of the decimal point (selectable).
<b>Sampling Range</b>	Analog input: 150 msec/per scan Thermocouple or Platinum RTD: 400 msec/per scan.
<b>RS-485 Communication</b>	MODBUS® ASCII/RTU communication protocol.
<b>Vibration Resistance</b>	10 to 55Hz, 10m/s <sup>2</sup> for 10 min, each in X, Y and Z directions.
<b>Shock Resistance</b>	Max. 300m/s <sup>2</sup> , 3 times in each 3 axes, 6 directions.
<b>Ambient Temperature</b>	32°F to 122°F (0°C to +50°C).
<b>Storage Temperature</b>	-4°F to 150°F (-20°C to +65°C).
<b>Altitude</b>	2000m or less.
<b>Relative Humidity</b>	35% tp 80% (non-condensing).

Modbus® is a registered trademark of schieder automation.

Thermocouple Type and Temperature Range		
Input Temperature Sensor Type	LED Display	Temperature Range
Thermocouple TXK type	$\xi \xi \xi$	-328 ~ 1472°F (-200 ~ 800°C)
Thermocouple U type	$U$	-328 ~ 932°F (-200 ~ 500°C)
Thermocouple L type	$L$	-328 ~ 1562°F (-200 ~ 850°C)
Thermocouple B type	$b$	212 ~ 3272°F (100 ~ 2800°C)
Thermocouple S type	$S$	-32 ~ 3092°F (0 ~ 1700°C)
Thermocouple R type	$r$	-32 ~ 3092°F (0 ~ 1700°C)
Thermocouple N type	$n$	-328 ~ 2372°F (-200 ~ 1300°C)
Thermocouple E type	$E$	-32 ~ 1112°F (0 ~ 600°C)
Thermocouple T type	$t$	-328 ~ 752°F (-200 ~ 400°C)
Thermocouple J type	$J$	-148 ~ 2192°F (-100 ~ 1200°C)
Thermocouple K type	$K$	-328 ~ 2372°F (-200 ~ 1300°C)
RTD Type and Temperature Range		
Input Temperature Sensor Type	LED Display	Temperature Range
Platinum Resistance (Pt100)	$Pt$	-328 ~ 1472°F (-200 ~ 800°C)
Platinum Resistance (JPt100)	$JPt$	-4 ~ 752°F (-20 ~ 400°C)
Voltage Input Type and Input Range		
Voltage Input Range	LED Display	Temperature Range
0~50mV Analog Input	$\bar{n} u$	-999 ~ 9999
0V ~ 10V Analog Input	$u 10$	-999 ~ 9999
0V ~ 5V Analog Input	$u 5$	-999 ~ 9999
Current Input Type and Input Range		
Current Input Type	LED Display	Temperature Range
4 ~ 20mA Analog Input	$\bar{n} R4$	-999 ~ 9999
0~20mA Analog Input	$\bar{n} R0$	-999 ~ 9999

## PRECAUTIONS



### **DANGER! Caution! Electric Shock!**

1. Do not touch the AC terminals while the power is supplied to the controller to prevent an electric shock.
2. Make sure power is disconnected while checking the unit inside.
3. The symbol  indicates that this Controller is protected throughout by DOUBLE INSULATION or REINFORCED INSULATION (equivalent to Class II of IEC 536).



### **WARNING!**

**Mount the controller in a location that will not be subject to excessive temperature, shock, or vibration. All models are designed for mounting in an enclosed panel.**

1. Always use recommended solder-less terminals: Fork terminals with isolation (M3 screw, width is 7.0mm (6.0mm for 32B Series), hole diameter 3.2mm). Screw size: M3 x 6.5 (With 6.8 x 6.8 square washer). Screw size for 32B Series: M3 x 4.5 (With 6.0 x 6.0 square washer). Recommended tightening torque: 0.4 N.m (4kgf.cm). Applicable wire: Solid/twisted wire of 2 mm<sup>2</sup>, 12AWG to 24AWG. Please be sure to tighten them properly.
2. Do not allow dust or foreign objects to fall inside the controller to prevent it from malfunctioning.
3. Never modify or disassemble the controller.
4. Do not connect anything to the "No used" terminals.
5. Make sure all wires are connected to the correct polarity of terminals.
6. Do not install and/or use the controller in places subject to: Dust or corrosive gases and liquid, high humidity and high radiation, vibration and shock, high voltage and high frequency.
7. Power must be off when wiring and changing a temperature sensor.
8. Be sure to use compensating wires that match the thermocouple types when extending or connecting the thermocouple wires.
9. Please use wires with resistance when extending or connecting a platinum resistance sensor (RTD).
10. Please keep the wire as short as possible when wiring a platinum resistance sensor (RTD) to the controller and please route power wires as far as possible from load wires to prevent interference and induce noise.
11. This controller is an open-type unit and must be placed in an enclosure away from high temperature, humidity, dripping water, corrosive materials, airborne dust and electric shock or vibration.
12. Please make sure power cables and signals from instruments are all installed properly before energizing the controller, otherwise serious damage may occur.
13. Please do not use acid or alkaline liquids for cleaning. Please use a soft, dry cloth to clean the controller.
14. Wait at least one minute after power is disconnected to allow capacitors to discharge, and please do not touch any internal circuit within this period.
15. This instrument is not furnished with a power switch or fuse. Therefore, if a fuse or power switch is required, install the protection close to the instrument. Recommended fuse rating: Rated voltage 250 V, Rated current 1 A. Fuse type: Time-lag fuse.
16. Note: This controller does not provide overcurrent protection. Use of the product requires that suitable overcurrent protection device(s) must be added to ensure compliance with all relevant electrical standards and codes. (Rated 250 V, 15 Amps max). A suitable disconnecting device should be provided near the controller in the end-use installation.

## External Dimensions

Dimensions are in millimeter (inch)

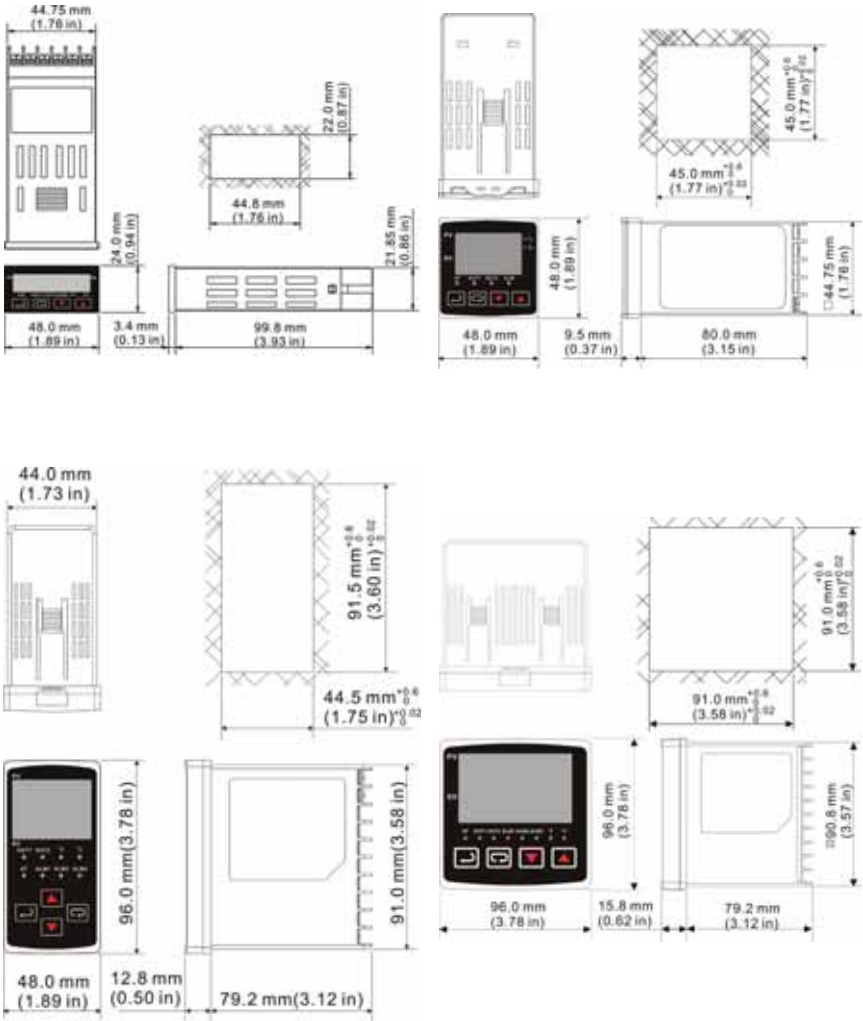

Printed in U.S.A. 8/10